

OWNER'S MANUAL & INSTALLATION GUIDE



ecoPLUS™ EP-1000-UV

PLEASE READ THIS MANUAL CAREFULLY BEFORE ATTEMPTING INSTALLATION. FAILURE TO FOLLOW THESE INSTRUCTIONS MAY AFFECT THE PERFORMANCE OF YOUR SYSTEM, VOID YOUR WARRANTY, AND RESULT IN PROPERTY DAMAGE.

Congratulations on the purchase of your ecoPLUS™ Series premium whole house water filtration system.

ecoPLUS™ EP-1000-UV is specifically engineered to treat city water by removing chlorine, chloramine, disinfection by-products, bad tastes and odors, and other trace contaminants including VOCs, pesticides, herbicides, organic chemicals, lead, and more. It also provides enhanced protection against bacteria, viruses, and other microorganisms. ecoPLUS™ delivers refreshing, great tasting drinking water, protects your skin and hair from the damaging effects of these contaminants, and gives you peace-of-mind.

To get maximum performance from your ecoPLUS™ system, we encourage to read this manual in its entirety before installation and operation of your filter.

IMPORTANT SAFETY SYMBOLS



Hazards or unsafe practices that may result in personal injury and/or severe property damage.



Hazards or unsafe practices that may cause operational problems with your water treatment system.

Table of Contents:

GENERAL WARNINGS	4
OPERATING CONDITIONS	5
INSTALLATION	6
Step 1 – Pre-Installation Inspection	7
Step 2 – Selecting an Installation Location	8
Step 3 - Load Media Tank	9
Step 4 – Attach Mounting Bracket to Housing Cap	11
Step 5 – Attach Housing Cap to Wall	12
Step 6 – Install Cartridge Filter and Attach Sump	13
Step 7 – Connect Outlet Assembly to the Bypass Assembly	13
Step 8 – Connect the Bypass Assembly to Valve Head	14
Step 9 – Connect the Inlet Assembly to the Housing Cap	14
Step 10 – Connect the Bypass to the Inlet Assembly	15
Step 11 – Mount & Install UV Sterilizer	17
Step 12 – Turn off the Water & Electric Water Heaters	17
Step 13 – Connect the System to Inlet and Outlet Pipes	18
Step 14 – Leak Testing and Media Conditioning	19
Step 15 – System Disinfection	21
TROUBLESHOOTING	21
MAINTENANCE	22
VALIDATIONS	25
SATISFACTION GUARANTEE	26
WARRANTY INFORMATION	26

GENERAL WARNINGS



Do not allow children or pets to play on or around the water filter.

Do not install or store this filter system where it will be exposed to freezing temperatures.

Do not tamper with controls.

Do not repair, replace, or attempt to service any part of the system unless specifically instructed to in this manual and you have the understanding, tools, and skills necessary to carry out the procedure.

Packing materials can be dangerous to children. Keep all packing material (plastic bags, polystyrene, boxes, etc.) well out of children's reach.

Individual components of this water treatment system, and the installed system, are heavy. Precautions should be taken to prevent personal injury or strain. Do not move heavy components without assistance if you are not physically capable of safely carrying out the procedure.

If the water treatment system is to be left unattended for an extended period of time (vacation, etc.), we strongly recommend that you turn off the water supply to the system, or the whole house, while you are away.

If your water pipes are metal (galvanized or copper), they may be used to ground electrical systems, appliances, or your phone line. If this is the case, be sure to install regulation ground clamps to the metal pipe on each side of the filter system and connect a jumper wire between the 2 clamps (#4 gauge solid copper wire recommended). Consult a certified electrician or plumber if you are unsure.

This water treatment system is designed specifically for the treatment of chlorinated city water supplies. ecoPLUS™ is not intended to be used to treat water from private wells or private surface water sources.

OPERATING CONDITIONS

The following chart provides guidance on the conditions required for successful operation of your ecoPLUS™ system.

This water treatment system is designed specifically for the treatment of chlorinated city water supplies. ecoPLUS™ is not intended to be used to treat water from private wells or private surface water sources. If you are unsure of the status of your water supply, please contact your dealer for assistance.



USE OF THIS EQUIPMENT OUTSIDE OF THESE OPERATING CONDITIONS MAY ADVERSELY AFFECT THE PERFORMANCE OF YOUR SYSTEM, RESULT IN SYSTEM DAMAGE INCLUDING WATER LEAKS AND CORRESPONDING PROPERTY DAMAGE, AND MAY VOID YOUR WARRANTY.

Minimum Water Pressure	20 PSI
Maximum Water Pressure	90 PSI*
Recommended Water Pressure	40-70 PSI
Water Temperature	36F to 100F (2 to 38C)
Minimum Air Temperature	32°F (0°C)**
pH Range	6.5*** to 8.5
Maximum Service Flow Rate	15 GPM (37 LPM)
Recommended Service Flow Rate	<10 GPM (25 LPM)
Water Supply	Treated City Water

* While the ecoPLUS™ system is built to withstand pressures exceeding 90 PSI, if your water pressure is greater than 70 PSI, we recommend that you have a certified plumber install a pressure reducing valve ahead of the ecoPLUS™ system.

** The system cannot be subjected to freezing conditions or severe damage to the system and your property could occur.

*** pH correction is strongly recommended where pH levels are less than 6.5 to prevent damage to your plumbing system, and to prevent the leaching of metals from copper and brass plumbing components and solder in your home. Contact your dealer for recommendations.

INSTALLATION



WE RECOMMEND THAT YOU READ THIS ENTIRE MANUAL BEFORE STARTING THE ACTUAL INSTALLATION. THE VIQUA UVMAX E4 (UV STERILIZER) OWNER'S MANUAL IS INTEGRAL TO THIS SYSTEM AND SHOULD BE READ IN DETAIL PRIOR TO INSTALLATION. THIS MANUAL IS ENCLOSED WITH YOUR UV STERILIZER. WHILE WE STRONGLY RECOMMEND THAT A LICENSED PLUMBER PERFORM ALL INSTALLATION WORK, A MECHANICALLY-INCLINED HOMEOWNER WITH SUITABLE PLUMBING KNOWLEDGE CAN INSTALL THIS SYSTEM. IN ALL CASES, IT IS CRITICAL THAT THE INSTALLATION BE DONE IN ACCORDANCE WITH THESE INSTRUCTIONS AND ALL APPLICABLE PLUMBING AND ELECTRICAL CODES. BE SURE TO OBTAIN ALL REQUIRED PERMITS. IF THESE INSTRUCTIONS AND THE APPLICABLE CODES ARE IN CONFLICT, THE RELEVANT PLUMBING/ELECTRICAL CODE SHALL BE FOLLOWED. EQUIPMENT FAILURE, PERSONAL INJURY, OR PROPERTY DAMAGE CAN RESULT IF THIS EQUIPMENT IS NOT INSTALLED PROPERLY.

KEEP THE MEDIA TANK UPRIGHT AT ALL TIMES.

John Guest® Quick-Connect Style Fittings

Several steps in the installation use a special type of quick connect fitting made by John Guest®. To connect a John Guest® fitting, unlock the fitting by turning the collet counter-clockwise until the fitting loosens. A small gap will open between the collet and the back of the fitting. Push the tube firmly into the fitting as far as it will go. Turn the collet clockwise until tight to secure the fitting. Pull out on the tube to ensure a good connection has been made. The pipe can be removed from the fitting by loosening the collet again and depressing the collar evenly while pulling outward on the tube.

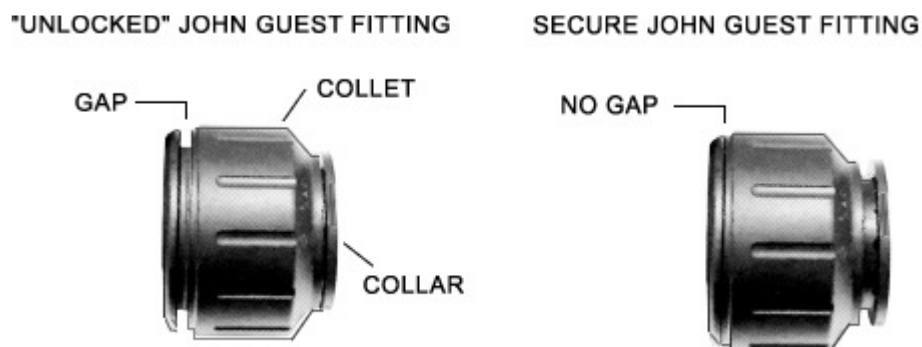

Step 1. – Pre-Installation Inspection

Inspect all of the components that you received with your unit. You should have received the following:

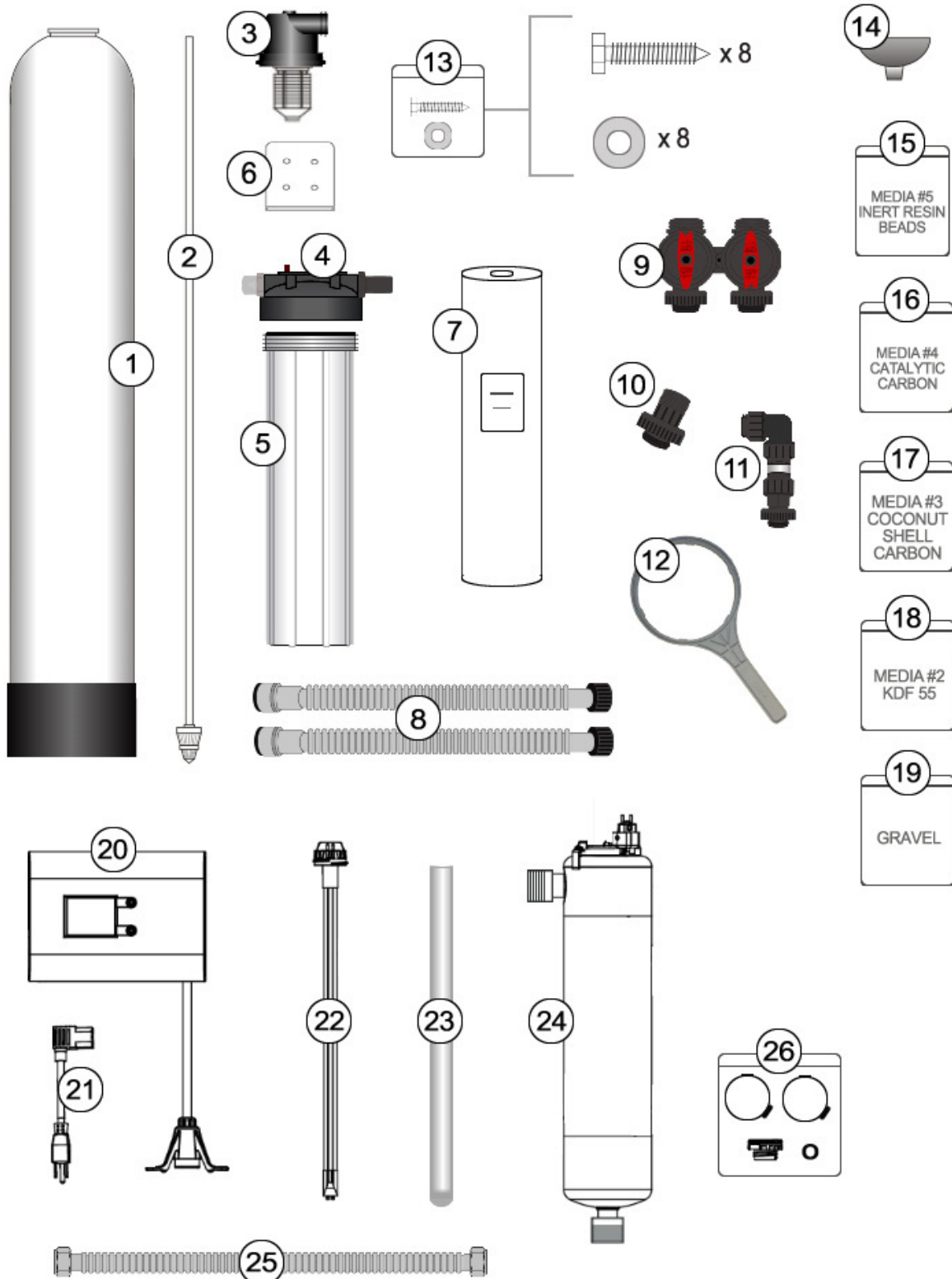

1. Media Tank
2. Riser Tube (shipped inside #1)
3. Valve Head w/ Upper Screen
4. Cartridge Filter Housing Cap
5. Cartridge Filter Housing Sump
6. Mounting Bracket
7. Sediment Pre-Filter (shipped inside #3)
8. Flexible Stainless Steel Connectors (1" Quick Connect to 1" NPT, 18")
9. Bypass Assembly
10. Outlet Assembly
11. Inlet Assembly
12. Spanner Wrench
13. Small Parts Bag (Contains: 8 Lag Bolts and 8 Washers)
14. Media Funnel
15. Inert Resin Beads (Media #5)
16. Catalytic Carbon (Media #4)
17. Coconut Shell Carbon (Media #3)
18. KDF 55 (Media #2)
19. Undebed Gravel (Media #1)
20. UV Controller
21. UV Power Cord
22. UV Lamp (do not touch the glass portion of the lamp!)
23. UV Sleeve (use gloves to handle the glass UV sleeve!)
24. UV Disinfection Chamber
25. Flexible Stainless Steel Connector (1" NPT to 1" NPT, 36")
26. UV Parts Bag (Contains: sleeve bolt, sleeve o-ring, and 2 chamber mounting clamps)

Step 2. – Selecting an Installation Location

While exterior installation in warm climate areas is possible, we strongly recommend interior installation only. The system cannot be allowed to freeze or severe system damage could occur. The system should not be exposed to rain and it should not be installed in direct sunlight, as long-term exposure to UV light could damage components of the system.

Select a location for installation of your water filter that is within close proximity to the main incoming water line of the home. The location should have a firm, level surface with enough space for the unit itself and sufficient space surrounding the unit to facilitate maintenance.

The approximate minimum installation space required for this model is:

31" Wide x 66" High x 22.5" Deep

In most cases, the system should be installed after the

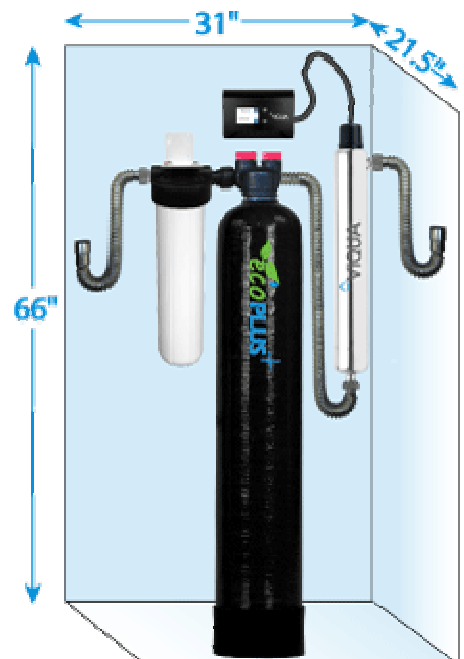

branch line(s) to exterior irrigation, unless you want your exterior faucets to deliver treated water. Depending on the configuration of your plumbing system, this is not always possible. ecoPLUS™ should be installed after your pressure tank and booster pump, if applicable, and before your hot water heater.



IF YOU HAVE OTHER WATER TREATMENT EQUIPMENT, YOU SHOULD DISCUSS THE ORDER OF YOUR TREATMENT EQUIPMENT WITH YOUR DEALER PRIOR TO INSTALLATION.



WHILE WATER LEAKS ARE VERY RARE AND UNEXPECTED, YOUR WATER FILTER SYSTEM SHOULD BE LOCATED NEXT TO A FLOOR DRAIN OR PROTECTED BY A WATER LEAK DETECTION SYSTEM WITH AUTOMATIC SHUT-OFF VALVE TO PREVENT WATER DAMAGE TO YOUR PROPERTY IN THE UNLIKELY EVENT OF A WATER LEAK. RECOMMENDED WATER LEAK DETECTION SYSTEMS ARE AVAILABLE AT WWW.A-LEAK-DETECTOR.COM.

Step 3. – Load Media Tank

Insert the riser tube assembly into the tank. One the end of the riser tube, there is a distributor which looks like a cone-shaped plastic screen. There is a recess in the center of the tank to accept the distributor to keep it properly aligned. The riser tube has been pre-cut to the correct height for you. When the distributor is correctly positioned, the top of the riser tube will be slightly below or flush to the top of the tank. If the tube is protruding above the top of the tank, the distributor is not nested correctly in the recess at the bottom of the tank.

Add enough water to the tank to cover the distributor with a minimum of 12 inches of water. This will prevent damage to the lower distributor as media is loaded. Place the funnel into the tank so that the riser tube is in the middle. Place tape over the open end of the riser tube. This will prevent gravel or media from accidentally going down the tube during the following steps.

For the following steps, we recommend that you wear the dust mask provided. Take the bag/box of gravel and, using a small scoop, add the gravel to the tank through the funnel to completely cover the distributor. Use all of the gravel. Be sure to provide some downward

pressure on the riser tube while adding the gravel to ensure that the distributor does not shift out of its recess or rise up. Ensure that you create an even layer of gravel across the bottom of the tank. Ensure that the riser tube remains centered in the opening at the top of the tank.

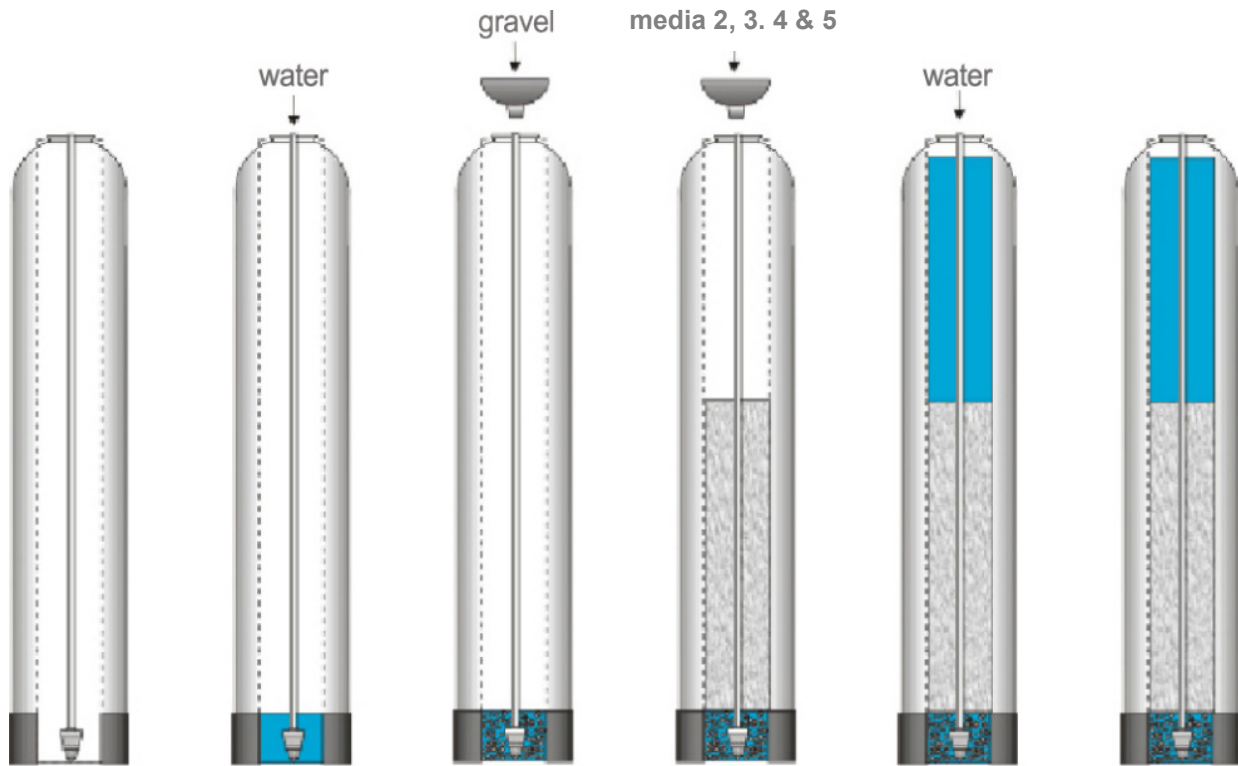

Once this is complete, add the KDF 55 Media next (marked Media #2) in the same manner. Use all of the KDF 55 media provided.

Next, add the Coconut Shell Activated Carbon (marked Media #3) in the same manner. Use all of the media provided. Using a small scoop to add the media slowly will help reduce dust.

Next, add the Catalytic Carbon (marked Media #4) in the same manner. Use all of the media provided. Using a small scoop to add the media slowly will help reduce dust.

Finally, add the Inert Resin Beads (marked Media #5) in the same manner. Use all of the media provided.

Depending on the capacity of the system, there will only be enough media to fill the tank to about 1/2 to 3/4 full. This is normal. The media tank should never be filled to the top of the tank as the remaining space, known as the “freeboard,” is necessary for the media to have room to expand during the service cycle.

Once you have finished adding the media to the tank, remove the tape from the distributor tube. Be careful not to pull upwards on the riser tube while doing this as it is important that the distributor remain in its recess at the bottom of the tank.

Fill the media tank with water up to within a couple of inches of the top of the tank. This will allow the media to pre-soak, thereby preventing media loss during the initial backwash.

Apply a small amount of lubricant to the top inch of the outside of the riser tube and to the large o-ring seal on the bottom of the ecoPLUS™ Valve Head. **Note: Only use food-grade silicone lubricant. A small tube of lubricant is provided in the small parts bag. Do NOT use petroleum jelly.**

The ecoPLUS™ Valve Head can now be secured to the top of the tank. Before attaching the Valve Head, check to make sure that there is no debris such as gravel or media in the tank threads. Screw the Valve Head onto the tank – make sure that the riser tube inserts into the center hole in the upper screen and the control valve as you screw down the valve. The control valve should be hand-tightened (clockwise). A firm grasp with both hands will work. Do not over-tighten. Do NOT use pipe cement (“pipe dope”) or Teflon® tape on the threads.

Step 4. – Attach Mounting Bracket to Housing Cap

Using four (4) of the lag bolts and washers from the small parts bag, attach the mounting bracket to the cartridge filter housing cap as shown in the diagram below. The inlet of the housing should be on the left.

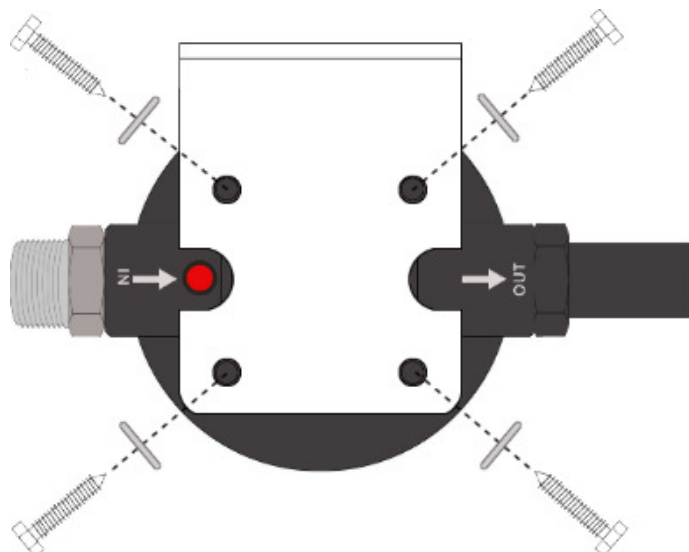

Step 5. – Attach Housing Cap to Wall

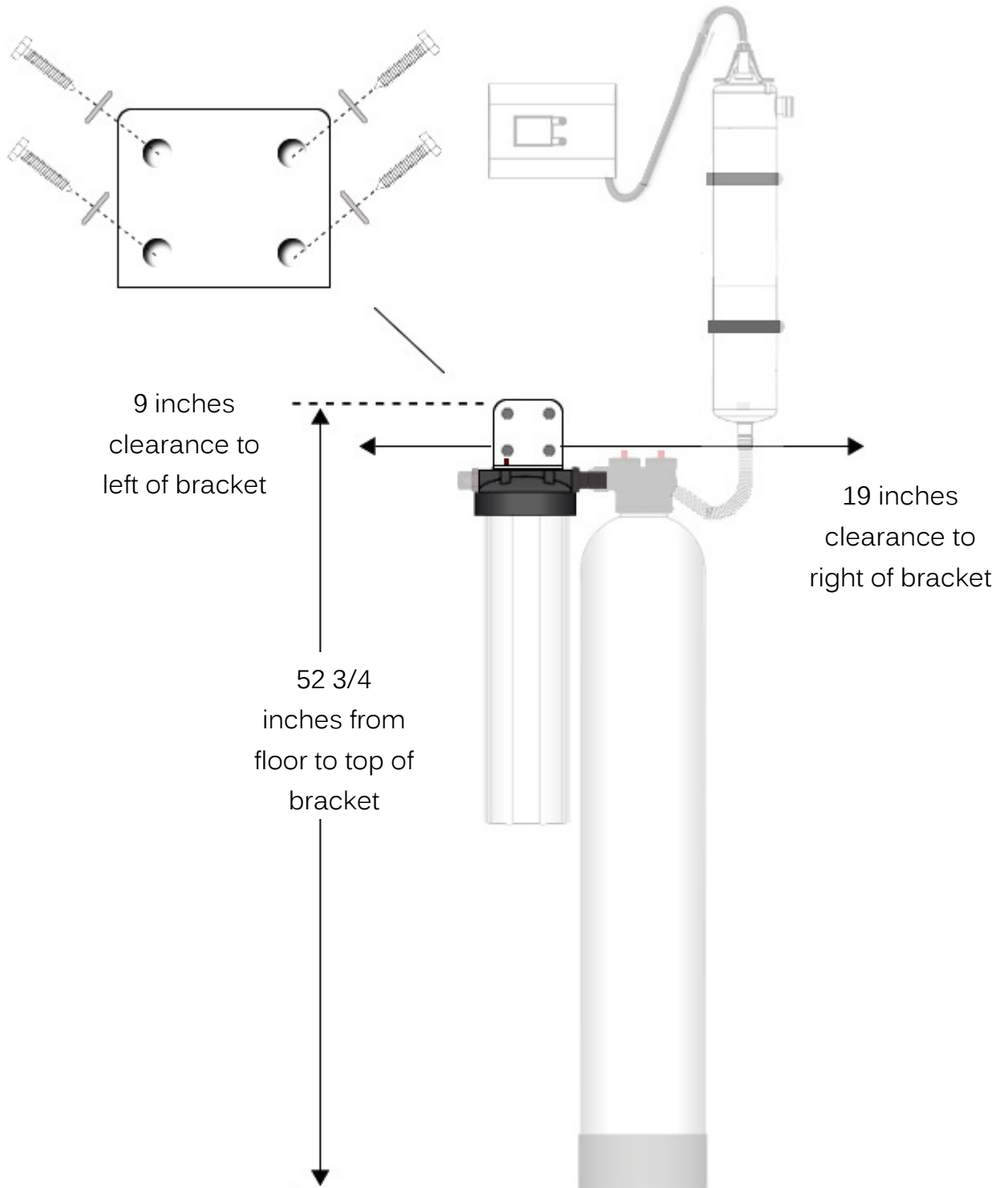

Attach the cartridge filter housing cap and mounting bracket to your wall using the remaining four (4) lag bolts and washers as shown below. **The top of the mounting bracket should be mounted EXACTLY 52 3/4 (52.75) inches off the floor.** Use a carpenter's

level to ensure that the bracket is mounted level to the floor. You will need to ensure that there is adequate space on either side of the bracket to accommodate the system. Ideally, you should have approximately 9-12 inches on the left and 19-22 inches on the right, although installation in a smaller space is possible.

If mounting to drywall, we recommend that you use suitable wall anchors or that you mount a small piece of 3/4 inch plywood to the wall first, ensuring that it is securely screwed into the wall studs. When the cartridge filter housing is full of water, it is heavy, so it is important to ensure that the mounting will be strong enough to support the weight.

Step 6. – Install Cartridge Filter and Attach Sump

Remove the protective plastic wrap from the sediment pre-filter and place it in the cartridge filter housing sump. At the bottom of the sump, there is a raised portion in the middle (standpipe) that will help center the filter in the housing. The standpipe will fit inside the hole that runs through the middle of the filter cartridge. Check to make sure that the black O-ring is seated properly in the groove at the top of the housing sump, then screw the housing sump containing the filter cartridge onto the cartridge filter housing cap. Hand tighten only - do not use the spanner wrench. Do not over-tighten! Excessive force is not required to obtain a good seal.

Step 7. – Connect Outlet Assembly to the Bypass Assembly

Thread the outlet assembly on to the outlet side of the bypass assembly as shown. Note the position of the fitting stop. The threaded collar of the outlet adapter should thread right up to the fitting stop.

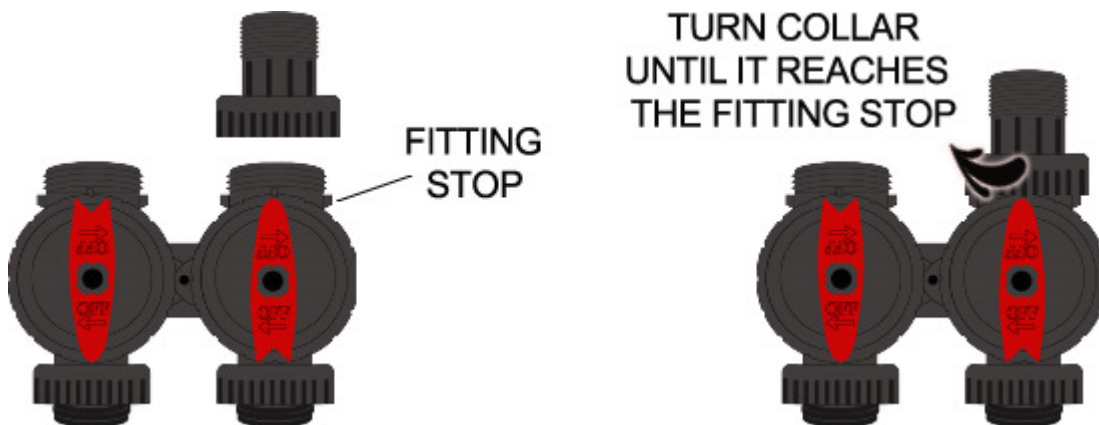

If there is a gap between the outlet adapter's collar and the fitting stop, it is not threaded on far enough. Excessive force is not required to obtain a good seal. Do not over-tighten.

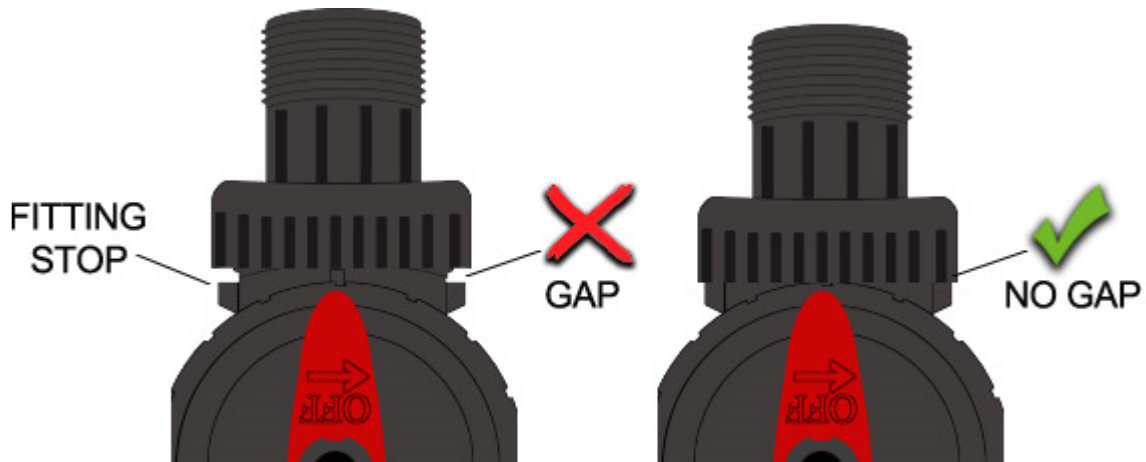

Step 8. – Connect the Bypass Assembly to Valve Head

Thread the bypass assembly on to the valve head on the ecoPlus™ media tank as shown. Again, note the position of the fitting stops. The threaded collars of the bypass assembly should thread right up to the fitting stops with no gap. Excessive force is not required to obtain a good seal. Do not over-tighten.

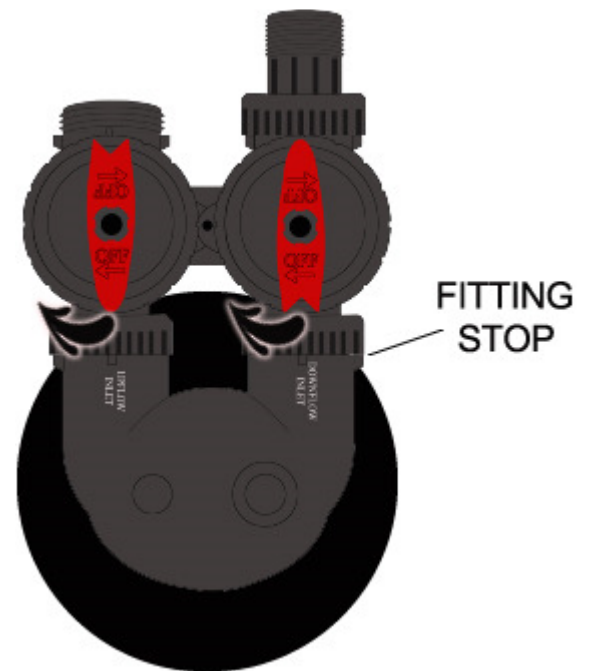

Step 9. – Connect the Inlet Assembly to the Housing Cap

Refer to [John Guest® Quick-Connect Style Fittings](#) above. First, ensure the John Guest® fitting is “unlocked.” Then push the elbow end of the inlet assembly on to the black stem adapter as far as it will go.

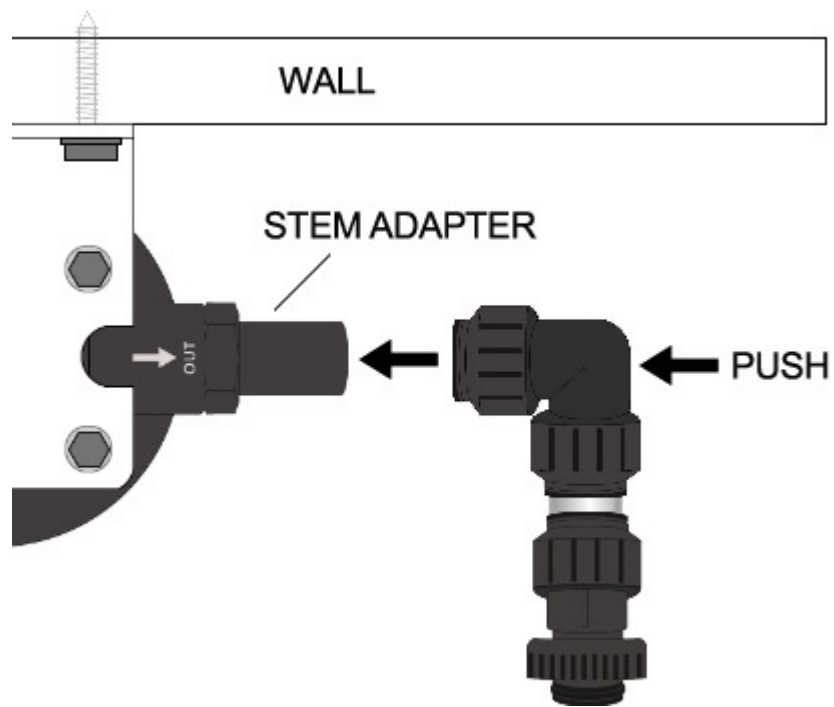

Then, turn the collet to securely lock the fitting.

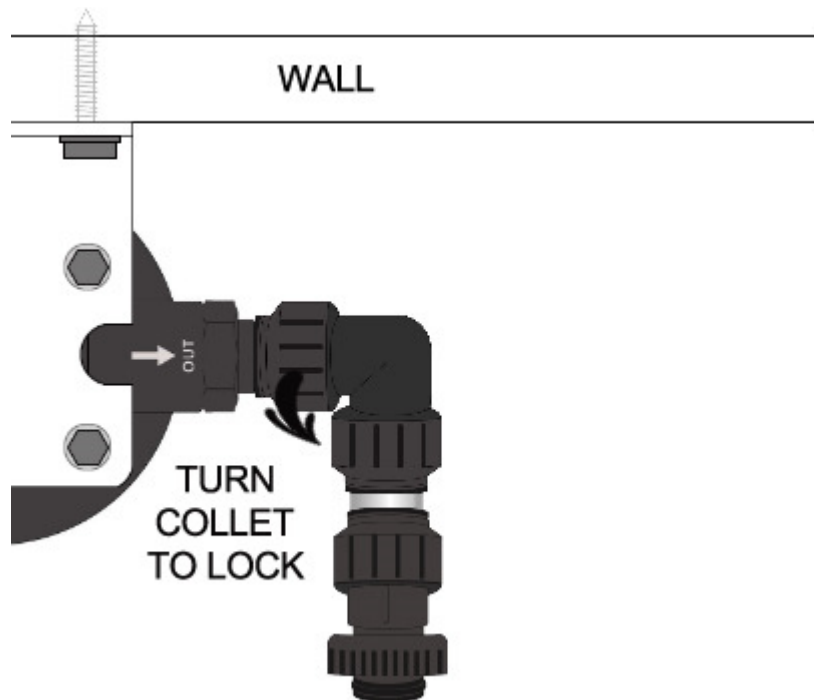

Step 10. – Connect Bypass to Inlet Assembly

Position the ecoPLUS™ media tank to align the bypass assembly with the inlet assembly attached to the cartridge filter housing cap.

Note that the black base of the media tank is not permanently attached to the rest of the tank. If your tank appears to be crooked, the base has likely been knocked out of alignment during shipping. This can be correct by picking the tank up and tapping it on a hard surface while holding it perpendicular to the floor. A few light taps will generally straighten it out.

Thread the inlet assembly on to the bypass assembly as shown in the same manner as previous steps. There is a small amount of “play” in the bypass assembly to help address minor misalignments. This is normal and will prevent undue stress on the components. Make sure that the tank sits perpendicular to the floor.

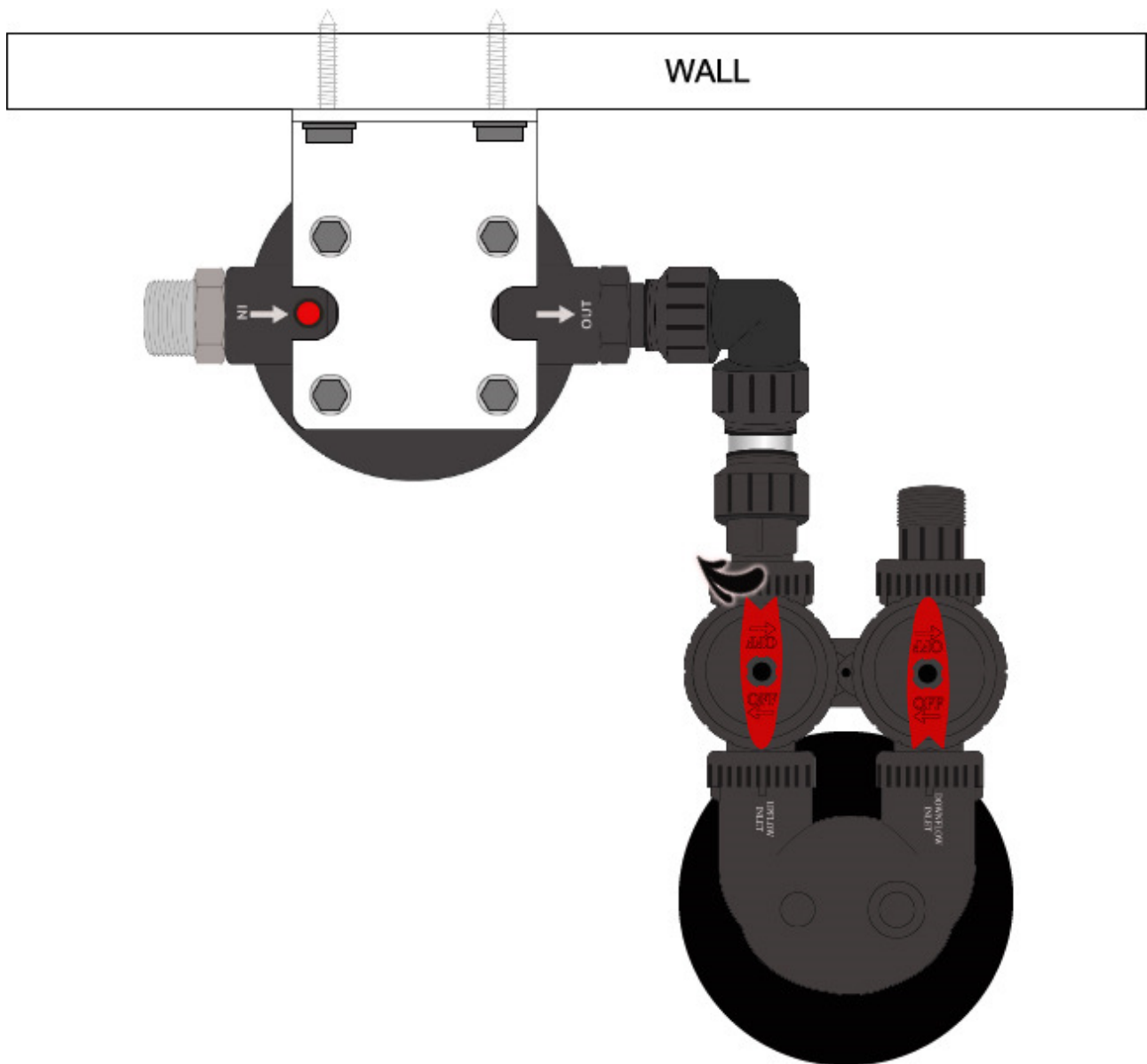

Step 11. – Mount and Install UV Sterilizer

Locate the 1" NPT to 1" NPT (36" long) flexible stainless steel connector. Connect one end of the flexible stainless steel connector to the outlet assembly on the ecoPLUS™ tank's bypass. It connects in the same way as a garden hose attaches to an outdoor faucet. Do not use Teflon® tape or other thread sealants and do NOT over-tighten. Excessive force is not required to obtain a good seal.

The other of the flexible connector attaches to the inlet (bottom port) on the UV disinfection chamber in the same manner. The flexible connector can be bent to reach the UV chamber which should be mounted securely on the wall behind your ecoPLUS™ media tank. The flexible connector is designed to be bent many times but not repeatedly over and over. Doing so may reduce the structural integrity of the fitting.

Follow the instructions in the *Viqua UVMax E4 Owner's Manual Section 3.1 "Installing UV System"* to mount and install your UV sterilizer. Be sure that you install the disinfection chamber such that the flexible connector can reach the inlet port at the bottom of the chamber. Also ensure that there is at least 27" of clearance above the UV sterilizer to allow for lamp and sleeve removal. Depending on the location of your outgoing water line, you can mount the outlet of the UV sterilizer so that its outlet port is on the right or left.

Step 12. – Turn Off Water & Electric Water Heaters



FAILURE TO FOLLOW THIS PROCEDURE COULD RESULT IN SERIOUS, PERMANENT DAMAGE TO THE HEATING ELEMENTS IN YOUR WATER HEATER.

If you have a conventional electric water heater or an on-demand (tankless) electric water heater, we highly recommend that you turn off the power to the heater while installing any water treatment equipment. Turn off power to your water heater now.

Turn off the household main water shutoff valve. Open several plumbing fixtures inside the home as well as the outside faucets to drain as much water out of the plumbing system as possible.

Following completion of the entire installation, restore the water flow by turning on the household main water valve and allow all air to be purged from the plumbing system before turning the power back on to your water heater.

Step 13. – Connect System to Inlet and Outlet Pipes

The 1 inch NPT stainless steel fitting on the inlet side of the cartridge filter housing cap should be plumbed to your incoming water supply pipe.

If within reach, this can be done with one of the 1" Quick Connect to 1" NPT flexible stainless steel connectors provided with your system if you have 1 inch PEX, copper, or CPVC water lines. The non-threaded end of the connector can be connected directly to 1 inch diameter PEX, copper, or CPVC tubing by pushing the fitting on to the tubing as far as it will go. Unlike the other John Guest® fittings used previously in the installation, there is no locking collet. The black end of the flexible stainless steel connector threads onto the stainless steel fitting in the same way as you would attach a garden hose to an outdoor faucet. Do not use Teflon® tape or other thread sealants and do NOT over-tighten. Excessive force is not required to obtain a good seal.

The flexible connector can be bent to reach your incoming water line. It is designed to be bent a many times but not repeatedly over and over. Doing so may reduce the structural integrity of the fitting.

Alternatively, you can make the plumbing connection between your stainless steel fitting on the cartridge filter housing cap and your incoming water line with suitable pipe tubing and fittings from your plumbing supply store.

Connect the outlet port on the UV sterilizer to your outgoing water pipe in the same manner using the other flexible stainless steel connector provided, or your own pipe tubing and fittings if preferred or required.

If desired, you can plumb in shut-off valves before and after the system and/or a bypass loop that can provide untreated water to your home during servicing.

Common Installation Configuration:

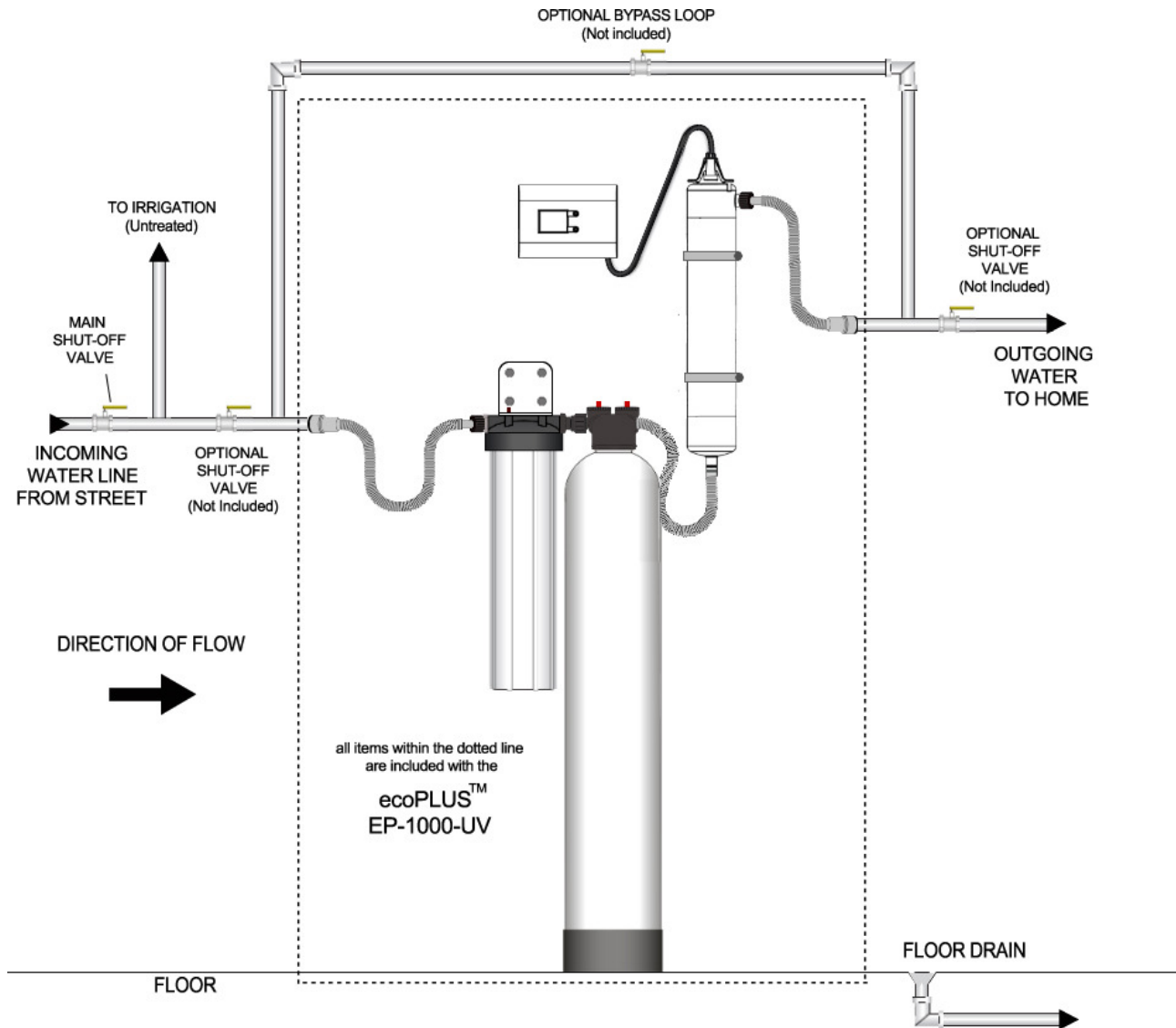

Step 14 – Leak Testing and Media Conditioning

Ensure that the bypass valve is in the “bypass” position (see next page for diagram).

Turn on the main water supply. Open a cold water tap nearby and let the water run for a few minutes until the system is free of foreign material and air that may have resulted from the installation. Once the water is running clear and free of air, close the water tap.

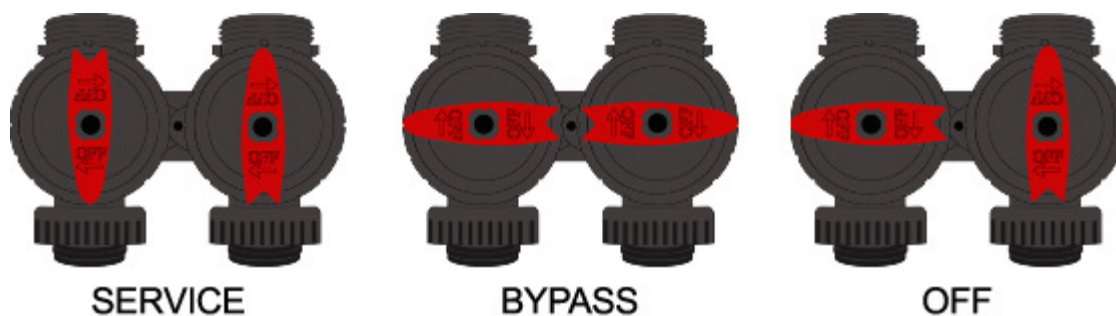

WARNING

INSPECT ALL PLUMBING CONNECTIONS AND THE INTERFACE BETWEEN THE MEDIA TANK AND ITS VALVE HEAD FOR LEAKS AND REPAIR ANY LEAKS FOUND BEFORE PROCEEDING.

IN PARTICULAR, INSPECT THE BUSHING ON THE OUTLET OF THE UV STERILIZER. WHILE THIS PART IS FACTORY INSTALLED, IT IS NOT LEAK TESTED DURING PRODUCTION. IF YOU GET A LEAK FROM THIS FITTING, TIGHTEN IT ACCORDINGLY AND RE-TEST.

Media Pre-Soak

Open the bypass valve to the “service” position. Slowly open a nearby faucet, allowing a slow flow of water. It may take several minutes for the flow of water to arrive as the media tank will be slowly filling with water. During this time, air will escape from the faucet. It is normal for the water to be highly discolored at this stage as carbon fines are purged from the system. Continue until all air is purged. Then, turn off the faucet and allow the media to soak for a minimum of twenty-four (24) hours. Set the bypass valve to the “bypass” position so you can use water during the media pre-soak process. Run the nearby faucet until the water runs clear.

It is now safe to turn the electricity back on to your water heater.

Final Media Rinse

After the media has soaked for at least twenty-four (24) hours, set the bypass valve to the “service” position again and open a nearby faucet and allow a slow flow of water to run for 5 minutes. Thereafter, gradually increase the flow rate until a moderate flow of water is achieved and run at this level for at least another 10 minutes. It is normal for the water to be discolored at this stage as carbon fines are purged from the system. Gradually increase the flow rate a little more and run the water until it is completely clear. If you notice a significant

decline in flow rate to the faucet at any point in the process, shut the water off and wait 10 minutes, then resume the process where you left off.

Step 15 – System Disinfection

Place the ecoPLUS™ bypass valve in the “bypass” position. Follow the instructions in the *Viqua UVMax E4 Owner’s Manual Section 3.2 “Disinfection Procedure”* to disinfect the UV sterilizer and downstream plumbing.

Familiarize yourself with the UV control panel functions by reading *Viqua UVMax E4 Owner’s Manual Section 4*.

Congratulations!

Your system is now ready to provide treated water to your home!

We recommend that you limit the use of high flow rate applications for the first few days of operation to allow your carbon media to be fully conditioned and saturated. It is common and normal for some carbon dust to be released from the filter in the first few days of operation. This carbon is harmless and will generally go away within about a week.

TROUBLESHOOTING

Problem	Solution
Reduced water pressure and/or flow rate after initial installation.	Limit high flow rate demands during the first few days of operation to allow time for the media bed to condition and saturate with water. If significant pressure loss is experienced, turn off water, wait 10 minutes and try again. Ensure flow rate demands do not exceed capacity specifications.
Reduced water pressure and/or flow rate at other times.	The sediment pre-filter may need to be replaced. In most cases, it should be replaced every 9 to 12 months. Ensure flow rate demands do not exceed capacity specifications.
Treated water is discolored.	During the initial start-up and for roughly the

first week after installation, you may notice small black specs or a grey/black discoloration caused by carbon fines (dust). This is normal and will go away on its own. The carbon dust is not harmful. Air trapped in your water lines after installation can sometimes cause the water to appear milky. If you fill a glass of water and it appears milky at first, but clears relatively quickly, this is likely due to micro air bubbles. This situation is harmless and will go away as the air is completely purged out of your system.

Troubleshooting information related to the UV sterilizer can be found in the *Viqua UVMax E4 Owner's Manual Section 6*.

MAINTENANCE



THE SYSTEM MUST BE DEPRESSURIZED BEFORE REMOVING ANY COMPONENTS FOR SERVICING. TO DEPRESSURIZE THE SYSTEM, CLOSE YOUR MAIN WATER SHUT-OFF VALVE AND RUN WATER AT SEVERAL FAUCETS.

Cleaning

The outside of your system, including cartridge filter housing and media tank, can be washed with a mild soap and water if desired. Do NOT use strong cleaners as they may cause damage to the system components.

Sediment Pre-filter

The sediment pre-filter should be replaced every 9 to 12 months or as necessary to provide satisfactory water pressure to your home. The life of the filter will depend on the amount of sediment in your feed water supply. If you notice reduced water pressure, it is likely that your pre-filter needs to be replaced.

The replacement filter cartridge for your system is: Hydronix SDC-45-2005

This is a unique multi-gradient 5 micron sediment filter with high dirt-holding capacity and improved water pressure performance. We strongly recommend the use of only genuine replacement filters in your system. While other filters may fit, they could compromise the performance of your system.

Filter Cartridge Replacement Procedure:

1. Turn off the water supply to the system using your main household water shut-off. Briefly open a faucet in the home to relieve pressure. Turn the bypass valve on your media tank to the "off" position as shown. Depress the red pressure release button on the top of the filter housing cap to allow any remaining pressure inside the housing to escape.
2. Unscrew the sump (bottom of the housing) from the cap using the spanner wrench (included with original purchase of your system).
3. Locate and remove the large O-ring at the top of the sump. Try not to remove any of the lubricant from the O-ring. The housing O-ring should be replaced at least once annually or at each filter change if any damage to the O-ring is noted (kinked, cracked, stretched, etc.), or if any leakage between the housing cap and the housing sump cannot be stopped. Put the O-ring in a safe place where it will not get dirty or otherwise contaminated. **Replacement O-Ring: Pentek Buna-N Big Blue O-Ring #151122**
4. Take out the used filter cartridge and discard it.
5. Scrub the inside of the sump and underside of the housing cap with dish soap and warm water using a sponge or soft cloth. Fill the sump 1/3 with water and add about 2 tablespoons of unscented household bleach. Scrub to disinfect (we recommend that you use rubber gloves). **Rinse all parts thoroughly!**
6. Lubricate the O-ring with food-grade silicon lubricant if needed. Insert O-ring in the groove at the top of the sump and press into place. **Make sure the O-ring is seated level in the groove!**
7. Remove the protective plastic wrapping from the new filter cartridge and insert the cartridge into the housing sump, making sure that it slips over the standpipe in the bottom of the housing.
8. Screw the sump onto the housing cap and hand tighten. **Do not use the spanner wrench and do not over-tighten.**

9. Turn the bypass valve on the media tank back to the service position. Turn on the water supply slowly to allow the system to fill with water. **Inspect carefully for leaks.** If a leak is found, first inspect the O-ring to ensure that it is seated properly before tightening the sump more.
10. Flush the system by running water from a nearby faucet for 5 minutes. .

UV Sterilizer

To ensure optimal disinfection, your UV sterilizer requires lamp replacement every 12 months, and sleeve cleaning as necessary to ensure the sleeve remains clean. If you have hard water and are not using a water softener or our ecoTAC™ hard water conditioner, this may need to be done every few months. If you have soft water or you have treatment for your hard water problem, sleeve cleaning is generally only required once per year when your lamp is replaced. Over a period of time, the sleeve may become etched or damaged. If cleaning is no longer effective in restoring clarity to the sleeve, it should be replaced. Complete UV maintenance instructions can be found in the *Viqua UVMax E4 Owner's Manual Section 5*. This includes instructions to replace the lamp and to clean the sleeve.

The replacement UV lamp for your system is: #602806
The replacement UV sleeve for your system is: #602733



PLEASE NOTE THAT IT IS CRITICAL THAT ONLY GENUINE VIQUA REPLACEMENT PARTS BE USED IN YOUR UV STERILIZER. THE USE OF ALTERNATE PARTS MAY COMPROMISE THE DISINFECTION OF YOUR WATER RESULTING IN UNSAFE CONDITIONS, OR COULD CAUSE DAMAGE TO THE UV CONTROLLER. SUCH DAMAGE IS NOT COVERED UNDER THE MANUFACTURER'S WARRANTY.

Media Replacement

The media in you ecoPLUS™ system and ecoTAC filter are designed for a life of 5 years or 1,000,000 gallons, whichever comes first.

The replacement media kit for your ecoPLUS™ filter is: EP-1000-R

Detailed media replacement instructions are provided with the replacement media kit.

VALIDATIONS

Only the best components go into our ecoPLUS™ water treatment systems. They are sourced from some of the leading manufacturers in the business, and assembled at our factory in Canada. You can be assured that only the finest materials have gone into the manufacture of all ecoPLUS™ systems and that the materials used are safe for potable water contact. The following is a list of key system components:

Component	Manufacturer	Material Safety Validations
Valve & Bypass Assembly	Clack Corporation Windsor, WI, USA Made in USA	NSF/ANSI Standard 44 NSF/ANSI Standard 372
Media Tank	Pentair PLC Milwaukee, WI, USA Made in USA	NSF/ANSI Standard 42
Calgon Activated Carbon	Calgon Carbon Corporation Moon Township, PA, USA Made in USA	NSF/ANSI Standard 61
Centaur Catalytic Activated Carbon	Calgon Carbon Corporation Moon Township, PA, USA Made in USA	NSF/ANSI Standard 61
KDF-55 Process Media	KDF Fluid Treatment, Inc. Three Rivers, MI, USA Made in USA	NSF/ANSI Standard 42
Cartridge Filter Housing	Pentair PLC Milwaukee, WI, USA Made in Mexico	NSF/ANSI Standard 42
Cartridge Filter	Hydronix Water Technology Ontario, CA, USA Made in Taiwan	NSF/ANSI Standard 42
Quick Connect Fittings	The John Guest Group of Companies Middlesex, England Made in England	NSF/ANSI Standard 14 NSF/ANSI Standard 61 (G)
Flexible Stainless Steel Connectors	Falcon Stainless Inc. Temecula, CA, USA Made in China	NSF/ANSI 61 Section 9 ASME A112.18.6 CSA B125.6
UV Sterilizer	VIQUA (Trojan Technologies) Guelph, ON Canada Made in Canada	Stainless Steel UL USA/CAN

SATISFACTION GUARANTEE

ecoPLUS™ premium water treatment systems are backed by a 90 day satisfaction guarantee. If you are not completely satisfied with your ecoPLUS™ system, contact us within 90 days for assistance. In most cases, we can quickly help you resolve problems to your satisfaction. If not, you may return your system for a full refund less the actual original shipping cost to ship the product to you, or a full credit towards an alternative product. Of course, all ecoPLUS™ systems are also backed by our comprehensive warranty program (see below).



WARRANTY INFORMATION

ecoPLUS™ premium water treatment systems are backed by a comprehensive warranty program including Limited Lifetime Warranty on major components.



Major components, including the cartridge filter housing, media tank(s), riser tube(s), upper media screen(s), and tank valve(s) also known as an in/out valve, are warranted by HomePlus Products Inc. to be free of defects in material and workmanship for the life of the system, subject the limitations noted below.

Subject the limitations noted below, all other components are warranted by HomePlus Products Inc. to be free of defects in material and workmanship for the following periods:

ecoPLUS™ EP-1000 Series Media: 1,000,000 gallons or 5 Years whichever comes first, Pro-rated*

UV Sterilizer Chamber: 10 Years

UV Sterilizer Controller: 3 Years

All Other Components: 1 year

*Note: ecoPLUS™ systems are designed to treat water supplied by a public water utility. The

ecoPLUS™ and ecoTAC™ media warranties are void if supplied by untreated well or surface water, or if feed water falls outside of the specified operating conditions.

The term of these warranties begins on the date of delivery of the product to the customer and continues until the earlier of:

- the end of the warranty term noted above; or
- the date in which the product(s) is/are removed from the original location of installation; or
- the date in which the original purchaser sells or otherwise transfers ownership of the home in which the product(s) was/were originally installed.

Only products purchased from an Authorized Dealer or HomePlus Products Inc. directly are eligible for this warranty. The products must have been installed and operated in accordance with the instructions and operating conditions stated in the Owner's Manual.

Customer must register his or her warranty with HomePlus products Inc. within 90 days of original purchase for the warranty to remain valid.

This warranty applies only in Canada and the United States of America.

In the event that a part is deemed defective, the user must immediately inform HomePlus Products Inc. who will furnish a replacement part at no cost to the user. HomePlus' obligation to the customer shall be limited to the replacement of the defective part by prepaid standard freight to the original point of installation. Expedited shipping is available at the discretion and cost of the customer. When required, the return of defective parts to HomePlus is the responsibility of the customer.

This warranty does not cover any labour costs including labour costs related to troubleshooting, repair, installation, or maintenance.

This warranty does not apply to the following situations: misuse; normal wear and tear; neglect; unauthorized repair or damage caused through installation, adaptation, or modification; use in an improper manner or manner inconsistent with the manufacturer's installation, operating, and maintenance instructions; misapplication; wear or deterioration due to environmental conditions; damage occurring during transit; mishandling; improper storage; incorrect supply of water; tampering or alteration; fire, freezing; Act of god; or any cause beyond the control of HomePlus Products Inc.

The original warranty period does not change in the event of part replacement by HomePlus Products Inc.

This warranty is issued exclusively to the original consumer purchaser of record so long as the product remains installed in the original location of installation, and is not transferable.

The provisions of the foregoing warranties are in lieu of any other warranty, whether expressed or implied, written or oral (including any warranty of merchantability or fitness for a particular purpose). HomePlus Product Inc.'s liability arising out of the manufacture, sale, or supplying of the products or their use or disposition, whether based upon warranty, contract, tort, or otherwise, shall not exceed the actual purchase price paid by the authorized distributor or consumer for the product. In no event shall HomePlus Products Inc. be liable to the distributor or any other person or entity for special, incidental, consequential or punitive damages (including, but not limited to, property loss, loss of incomes, or loss of use damages) arising out of the manufacture, sale, or supplying of the products, even if HomePlus Products Inc. has been advised of the possibility of such damages or losses. These warranties are governed by the laws of the Province of British Columbia, Canada, and may change without notice.

To report a warranty problem with your system or request warranty service, please call HomePlus Products Inc. toll free: 1-866-376-2690

MANUFACTURED BY:



HomePlus Products Inc.

5-1490 Pearson Place
Kamloops, BC V1S 1J9
Canada

Phone: 250-374-2690

Fax: 250-374-2692

www.homeplusproducts.com